

Anker MX 15 15-25
Artikel: 113847

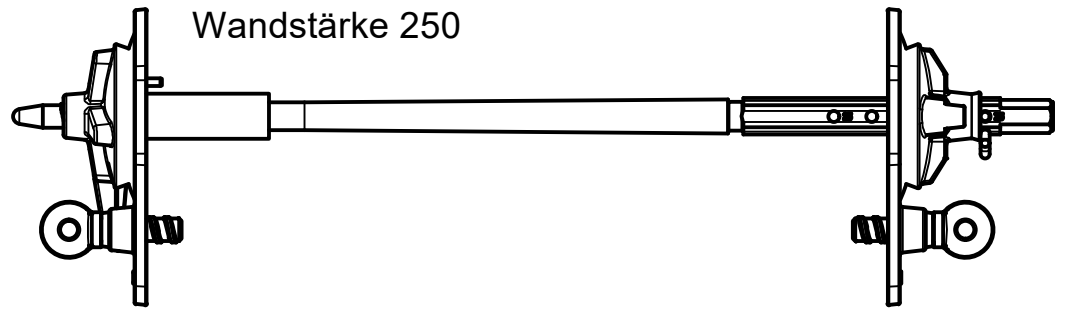

Anker MX 15 20-30
Artikel: 112387

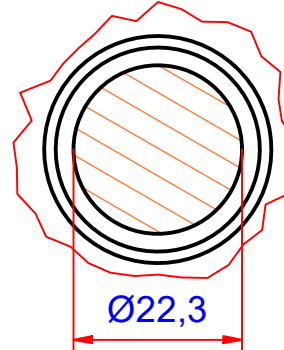
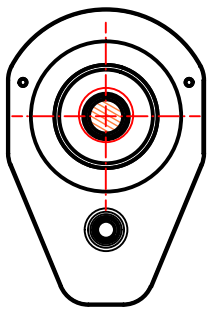
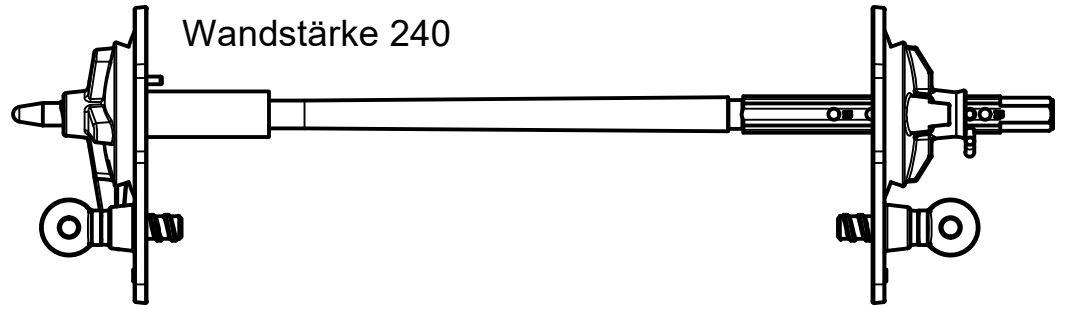
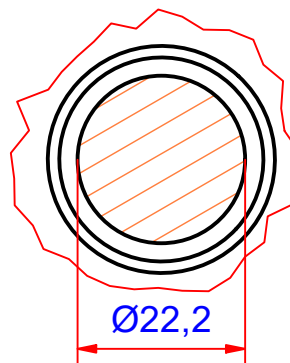
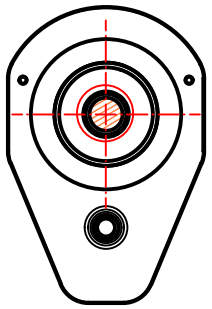
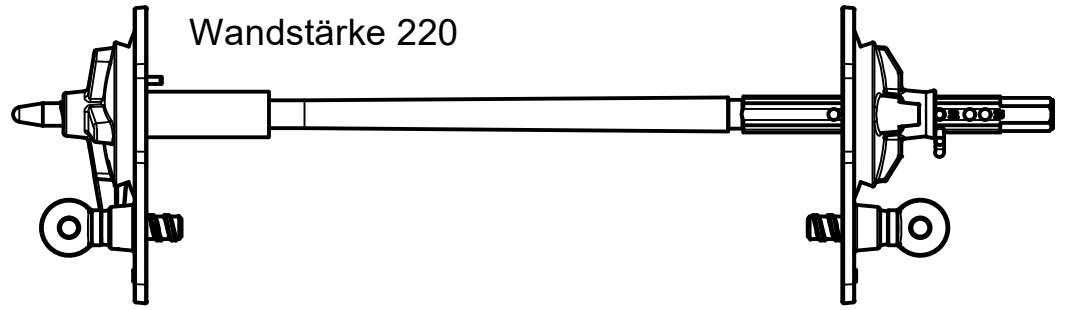
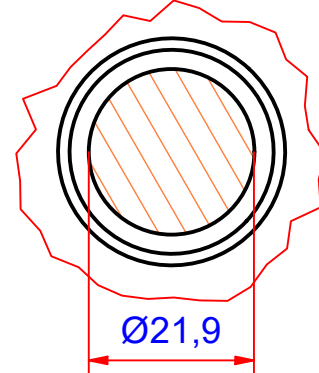
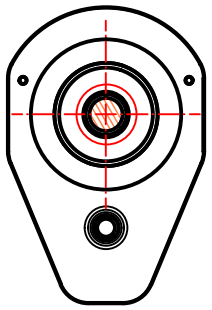
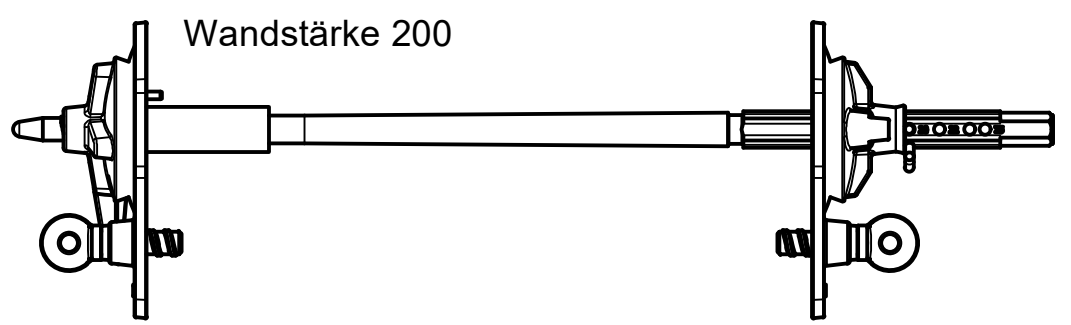
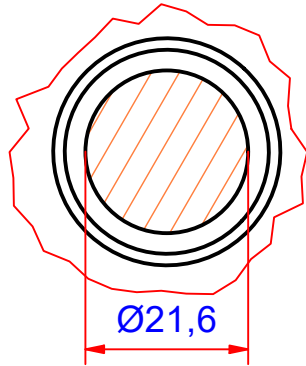
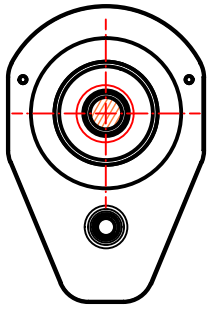
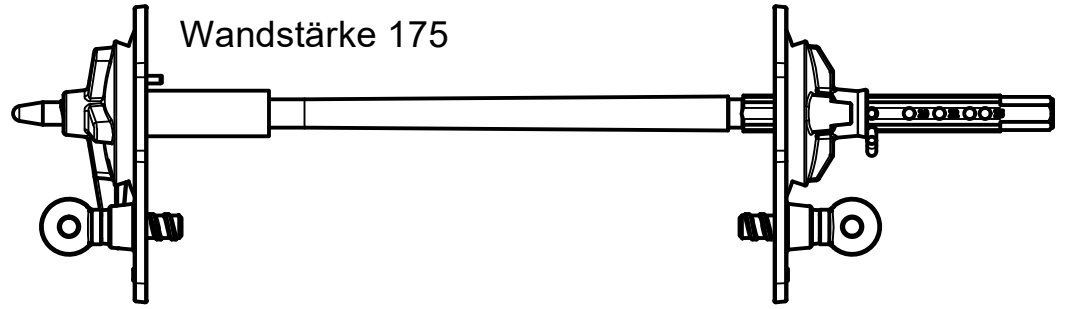
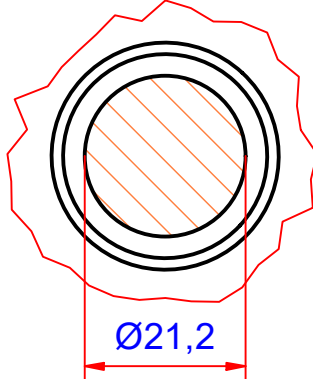
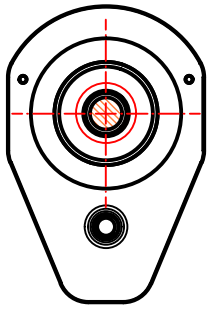
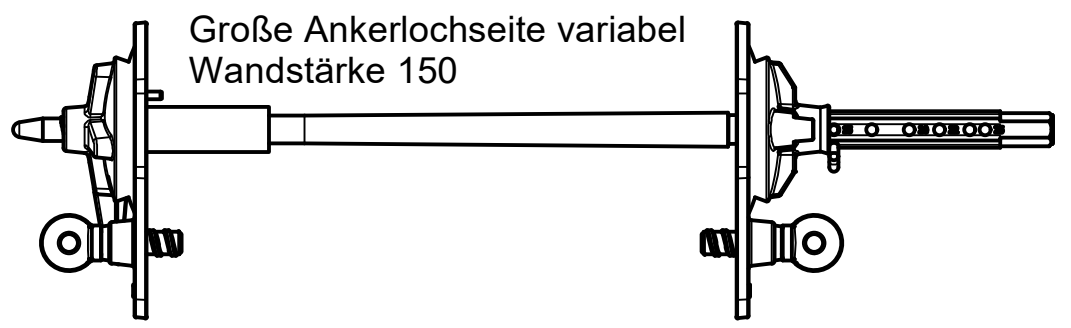
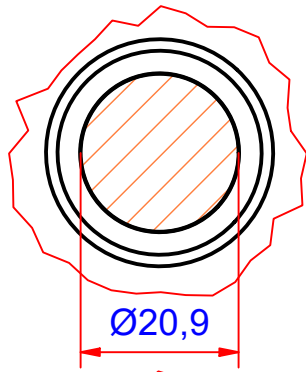
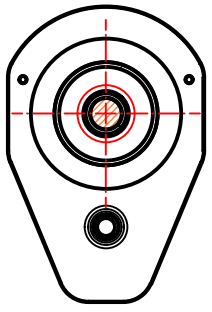
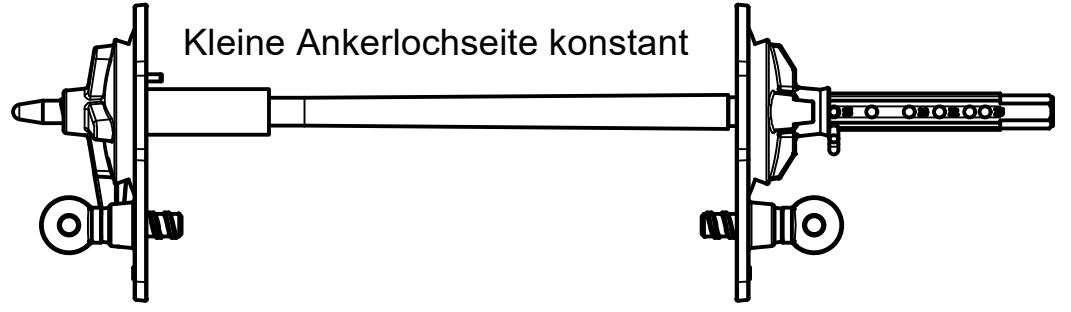
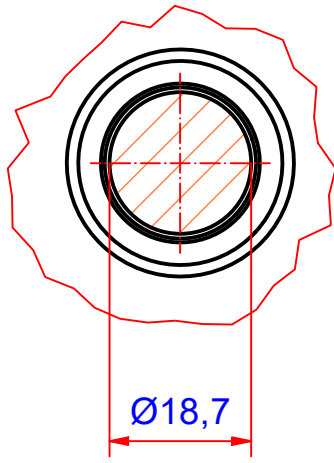
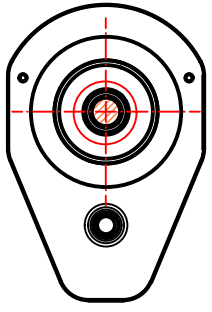
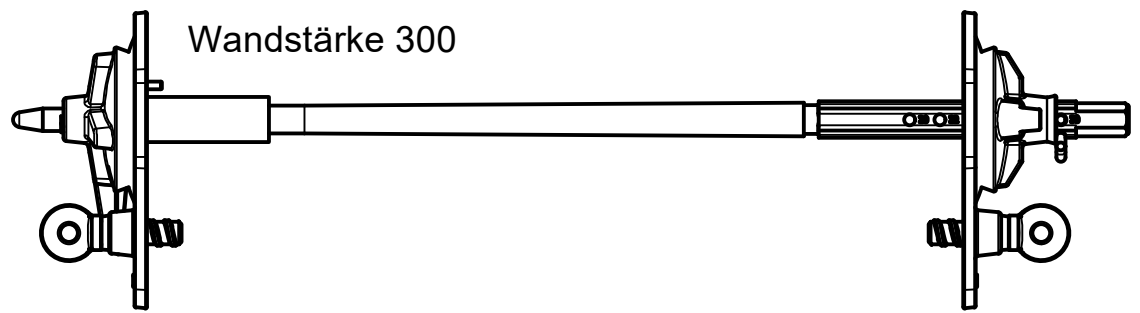
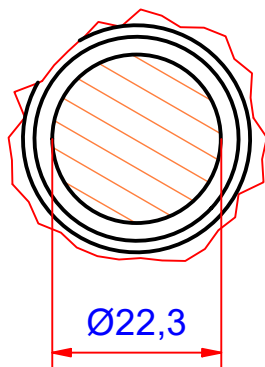
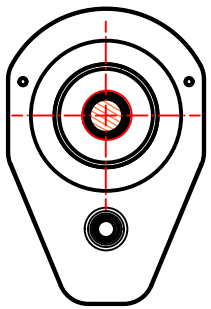
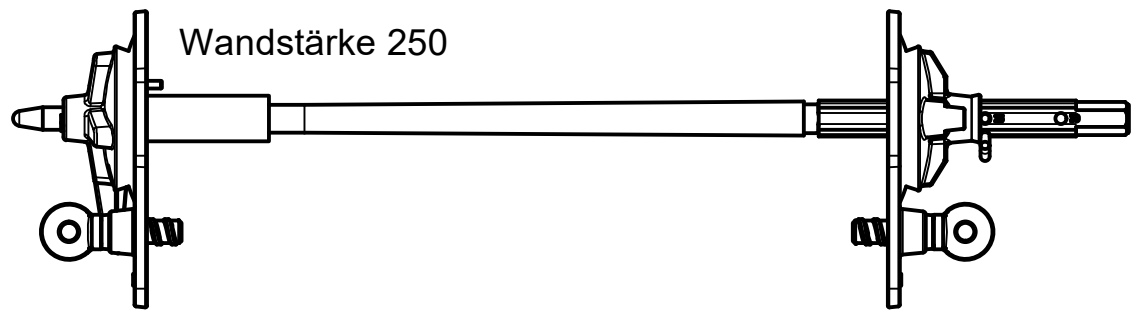
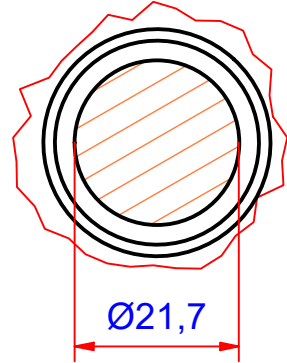
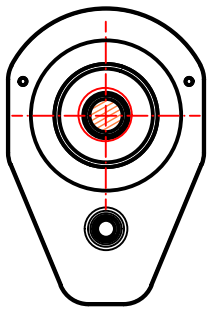
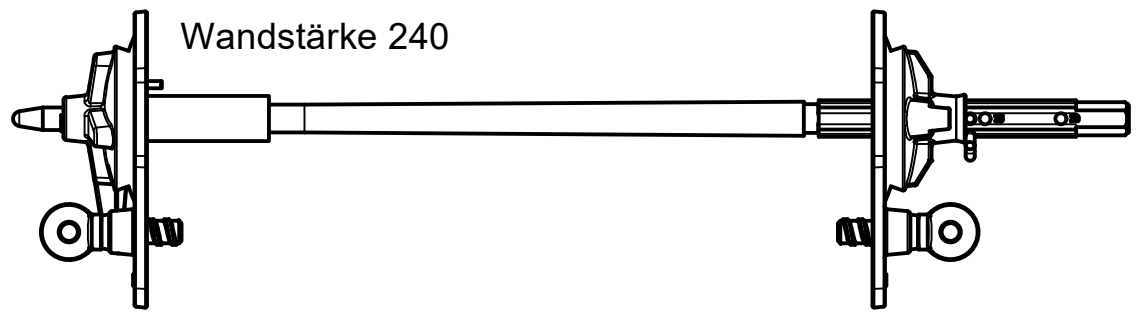
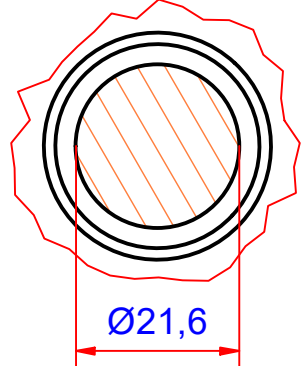
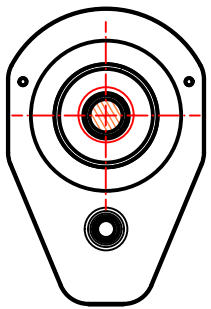
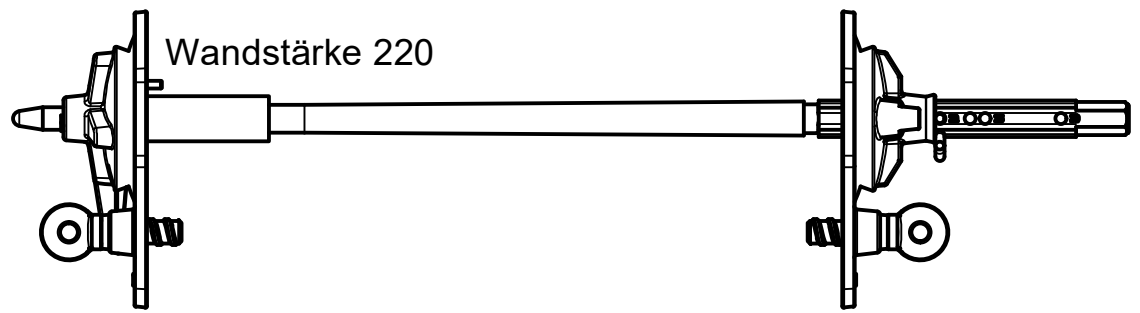
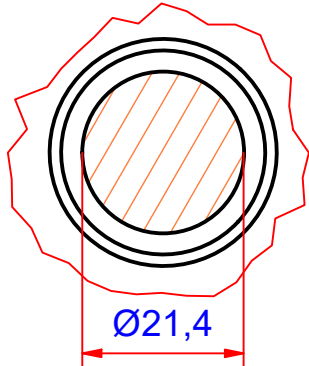
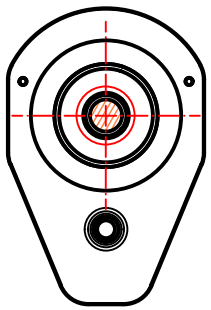
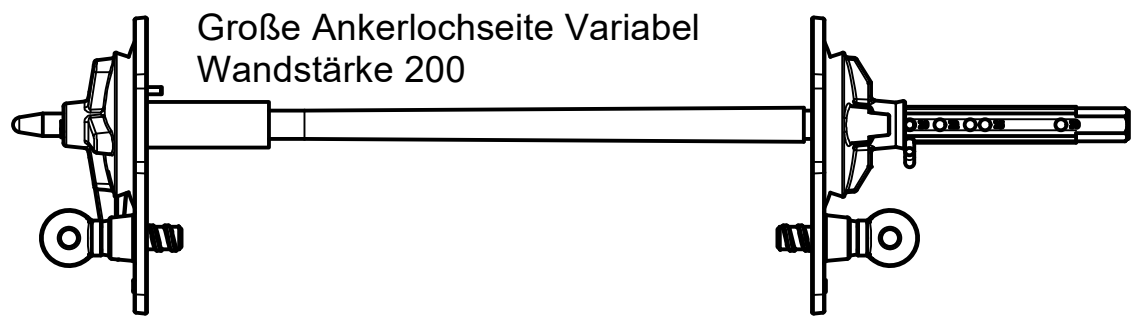
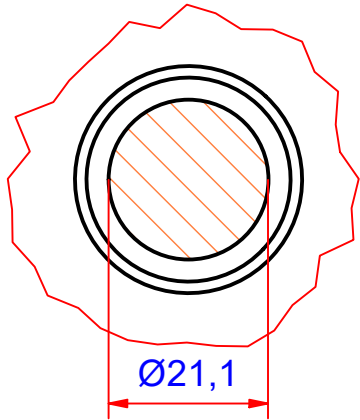
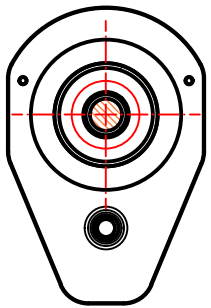
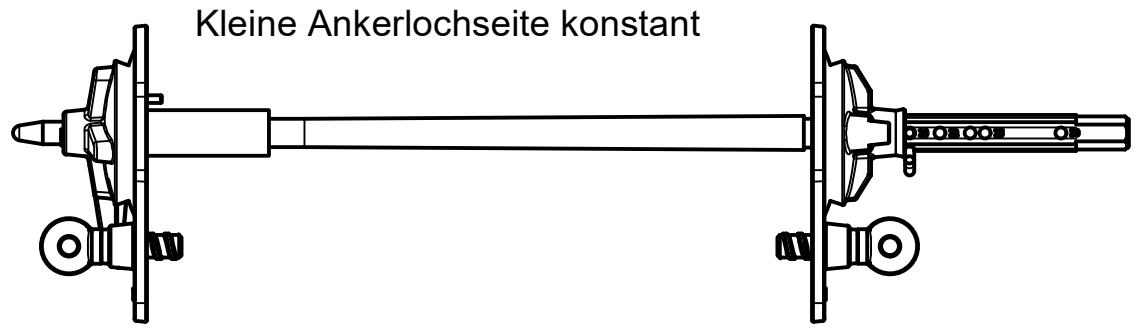
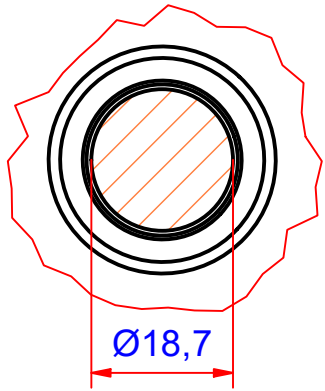
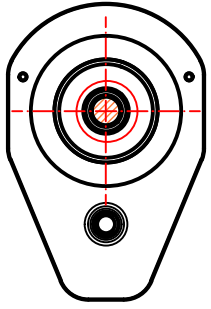

Anker MX 15 30-40
Artikel: 112464

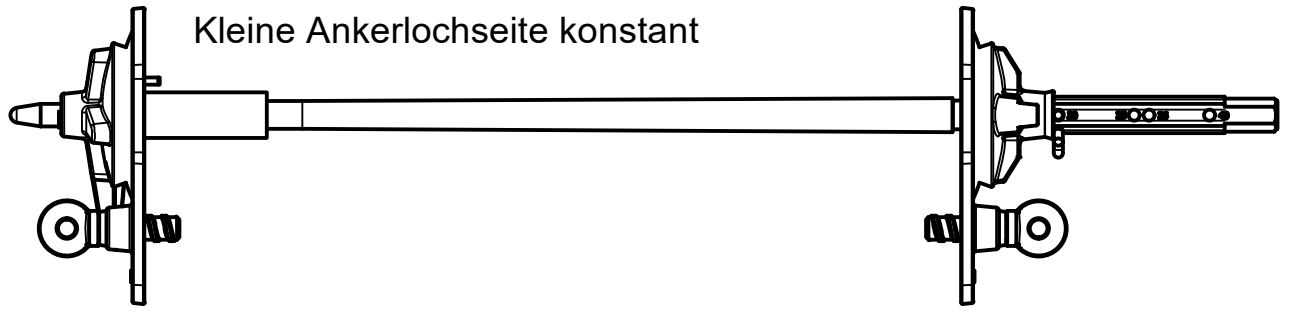
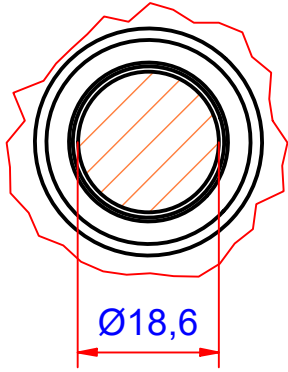
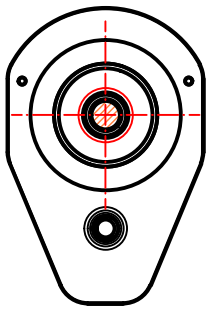

Kleine Ankerlochseite konstant

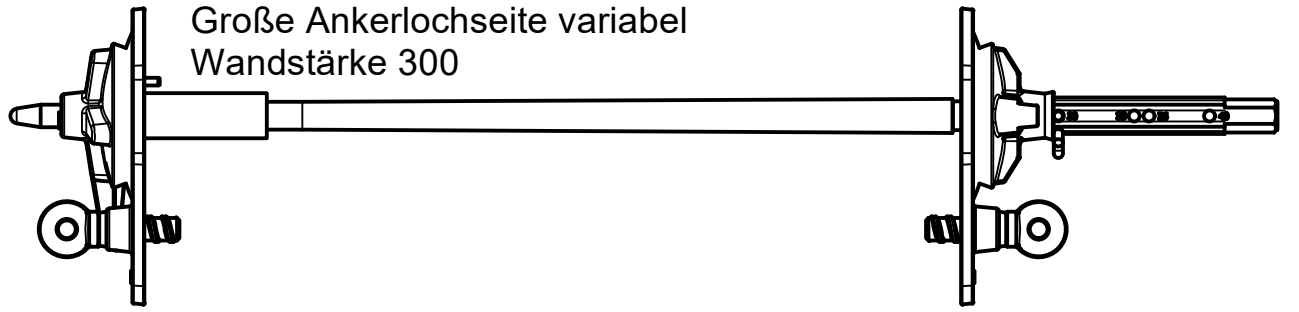
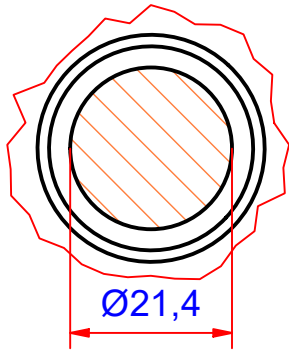
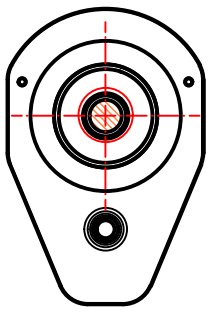

Große Ankerlochseite variabel
Wandstärke 300

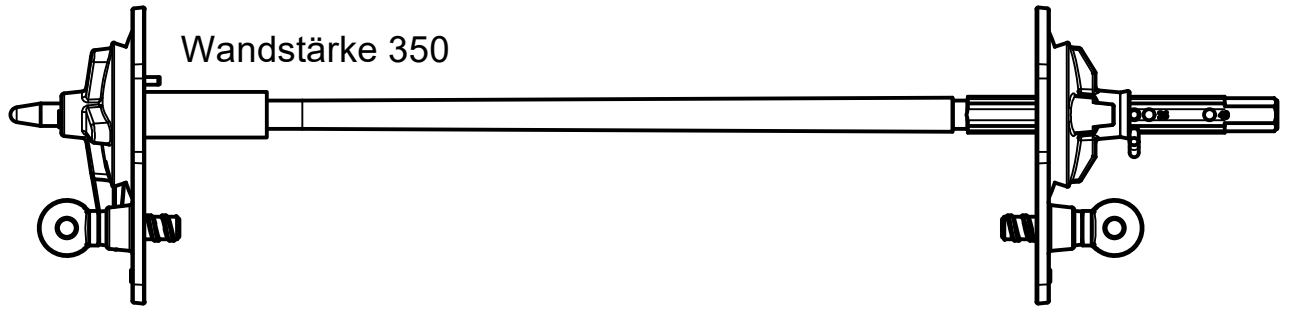
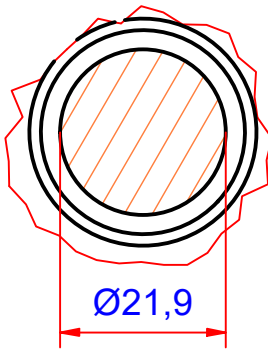
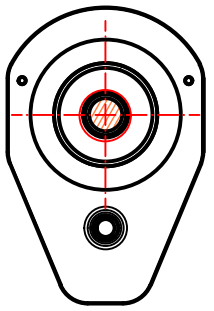

Wandstärke 350

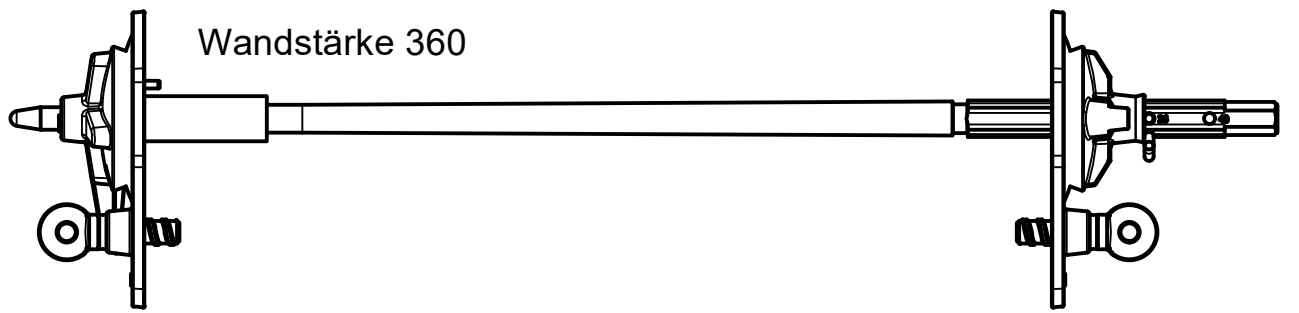
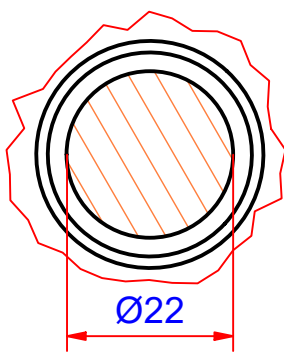
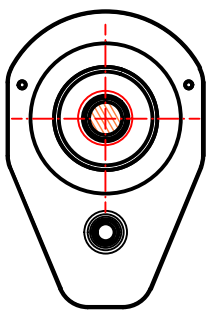

Wandstärke 360

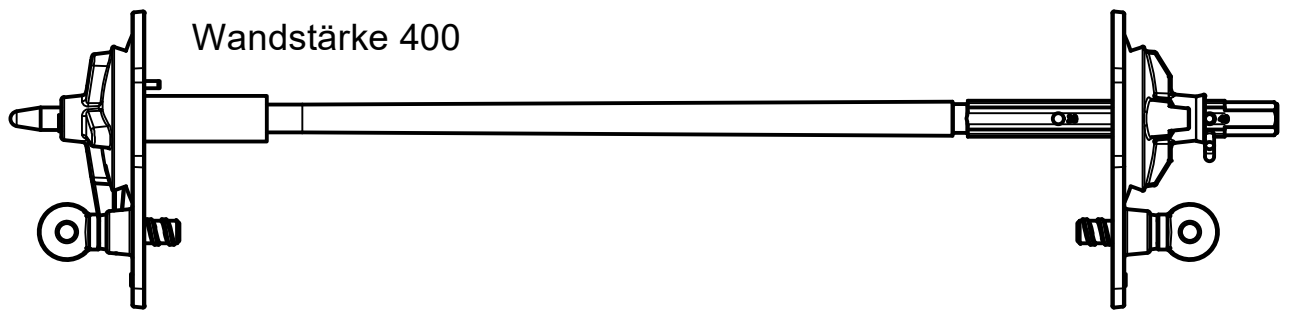
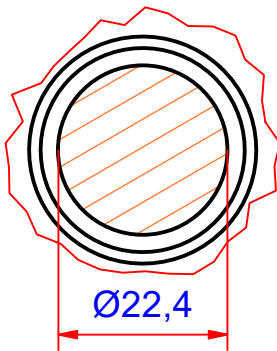
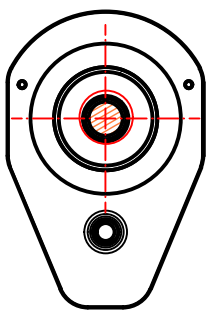

Wandstärke 400

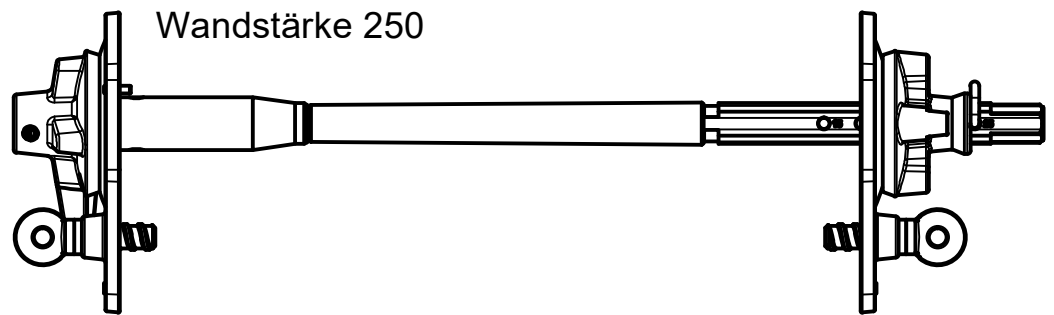
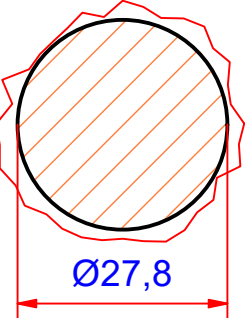
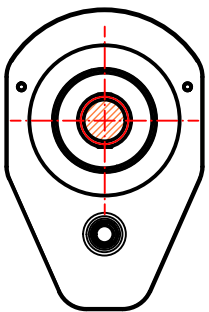
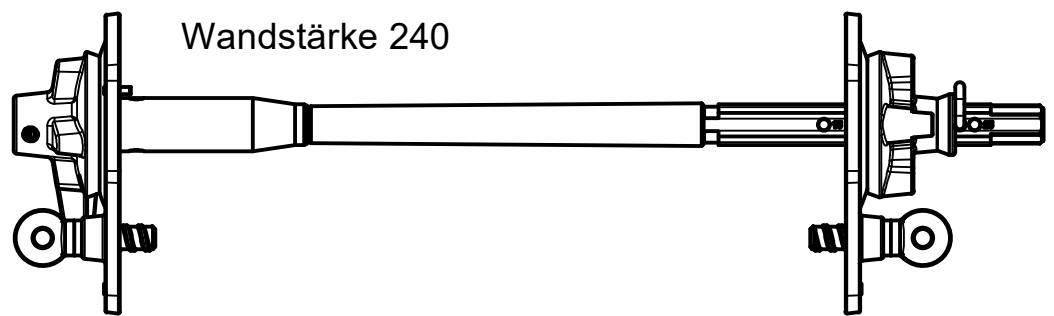
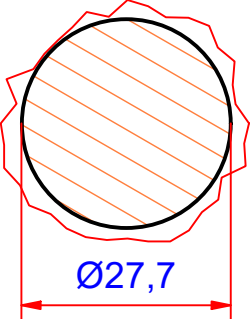
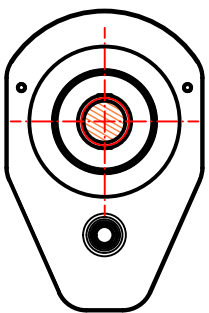
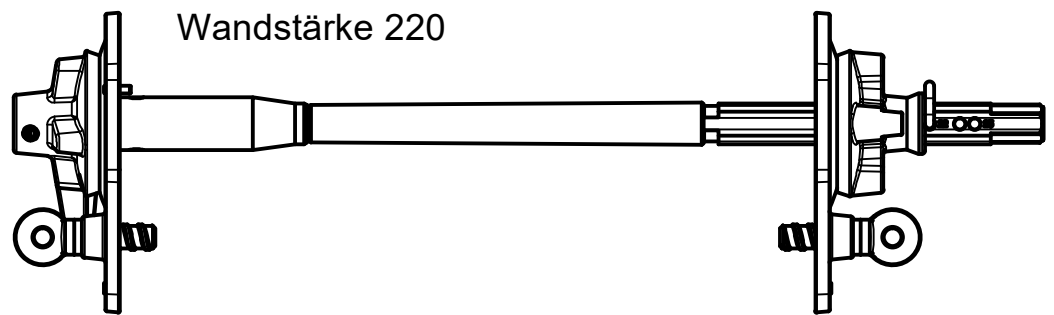
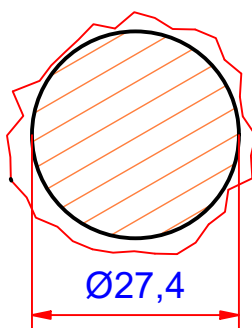
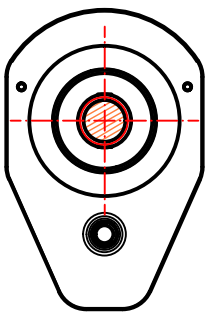
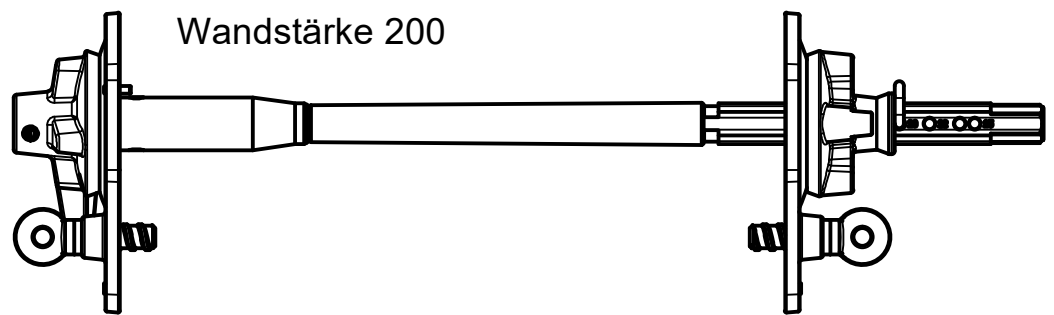
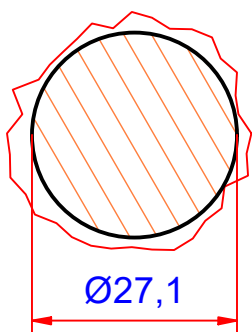
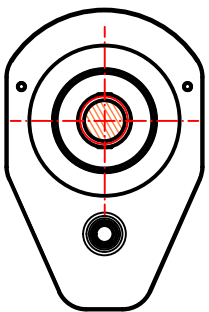
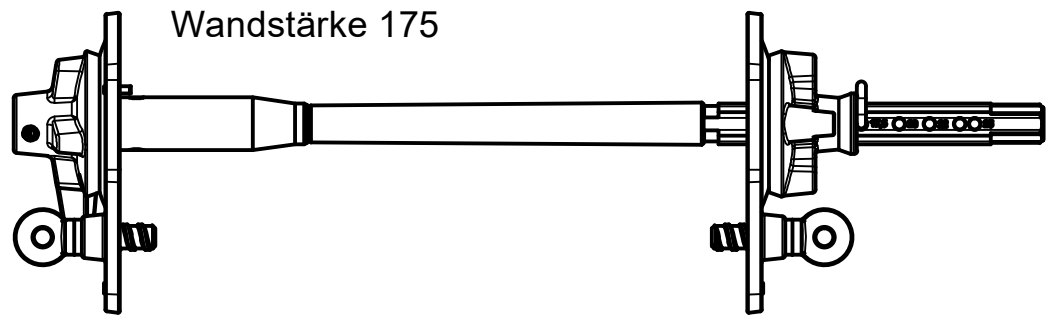
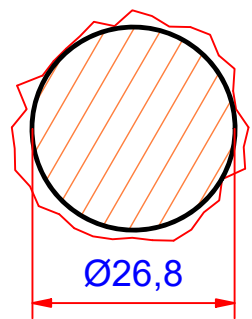
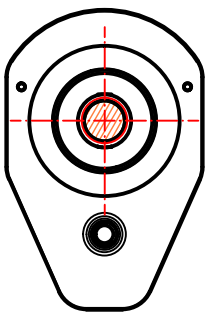
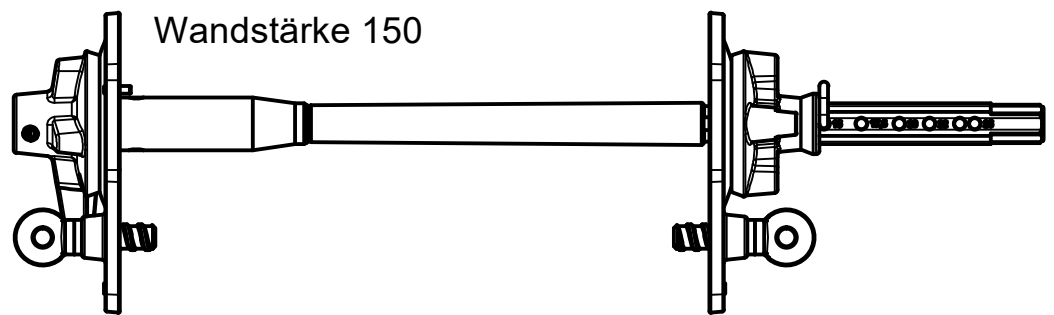
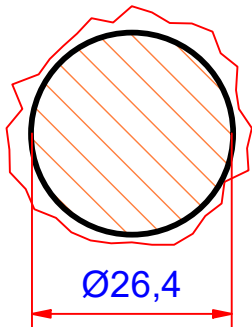
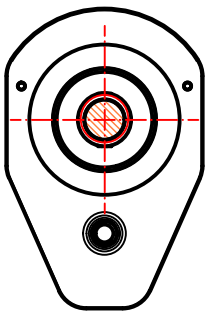
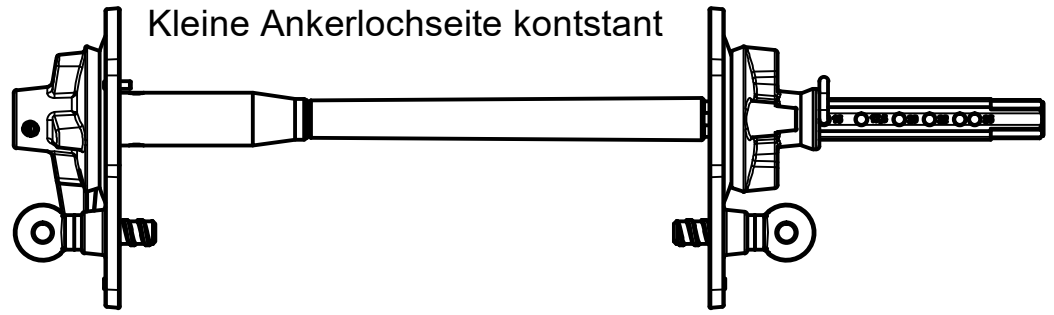
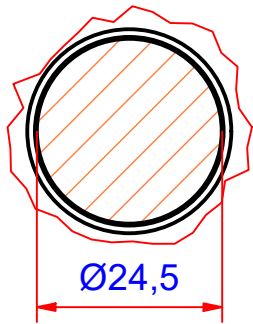
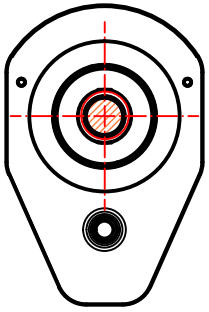

Anker MX 15 20-30
Artikel: 123902

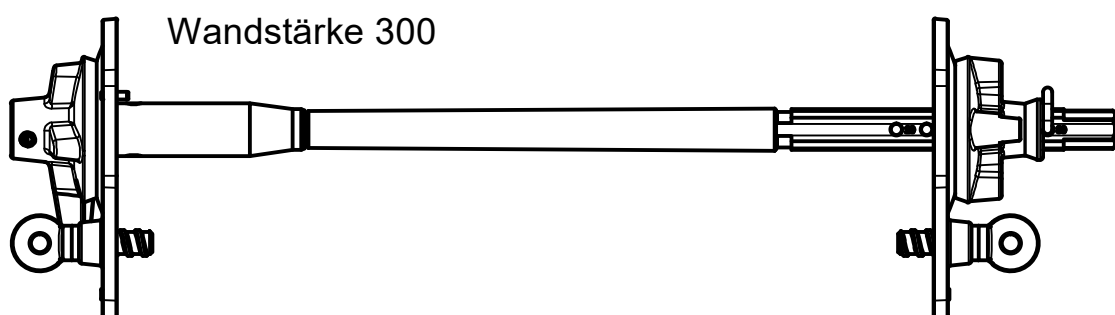
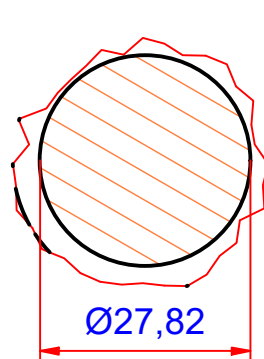
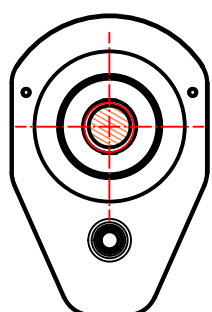
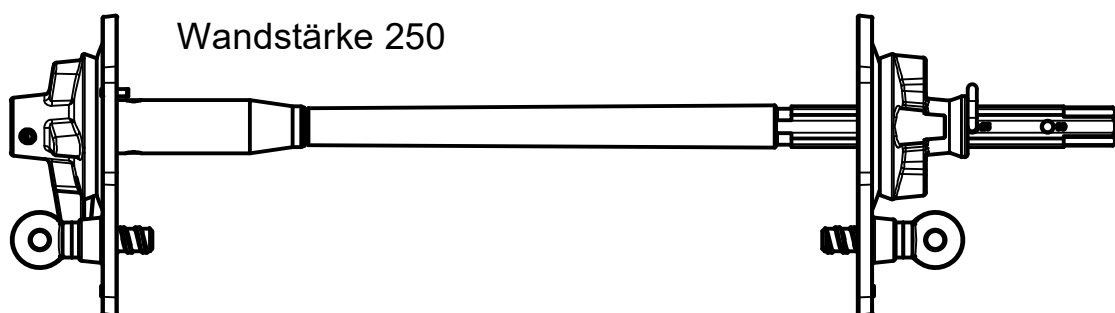
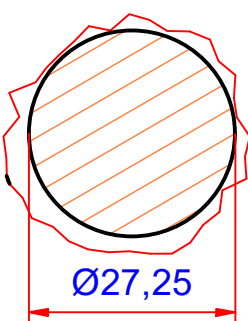
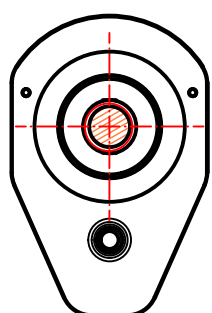
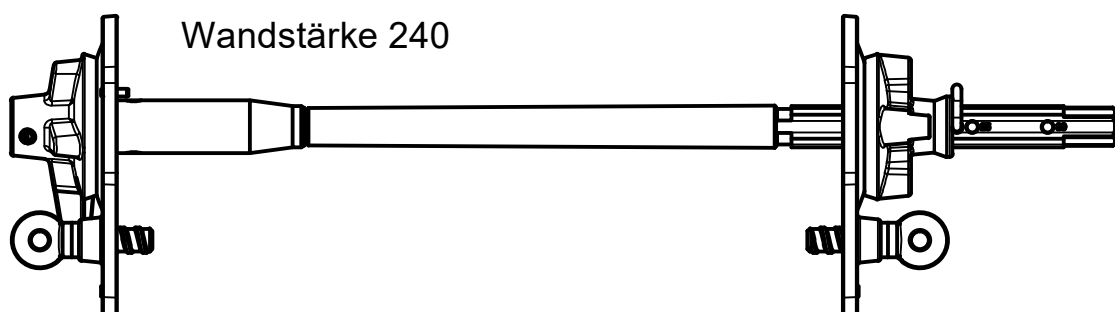
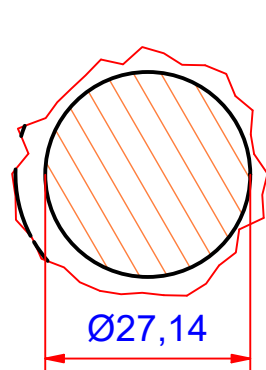
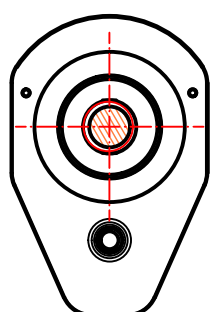
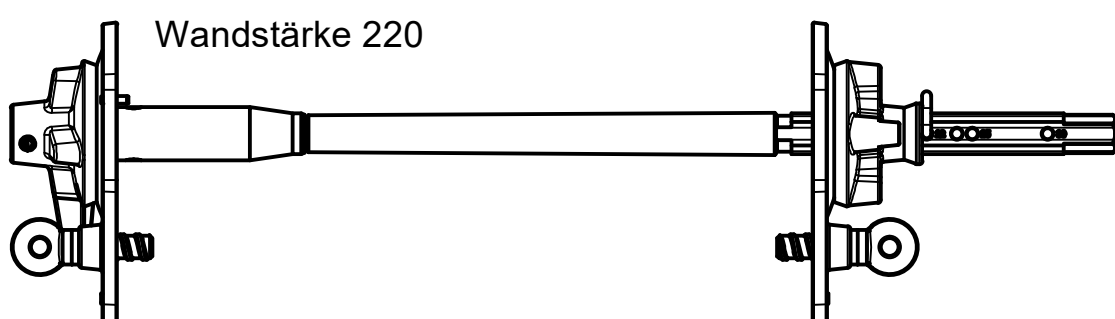
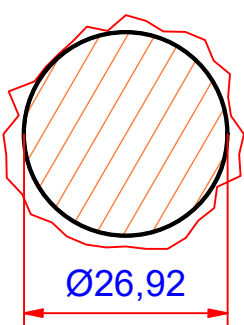
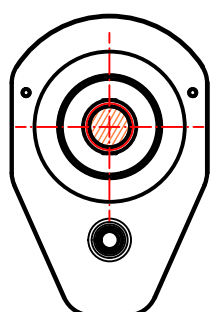
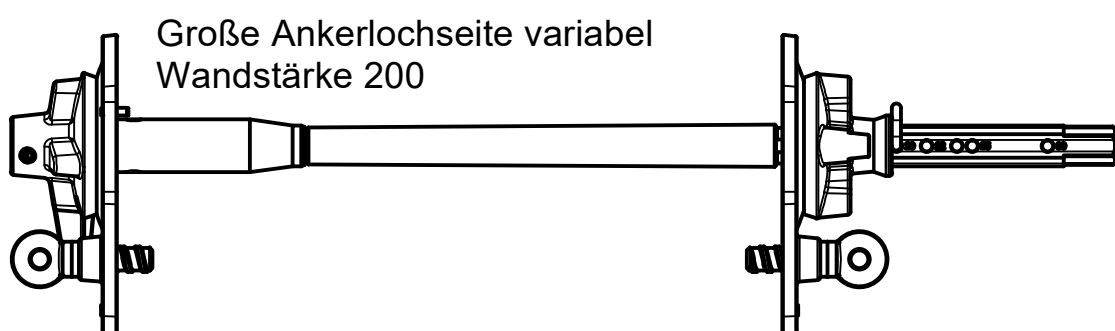
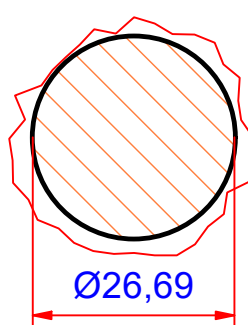
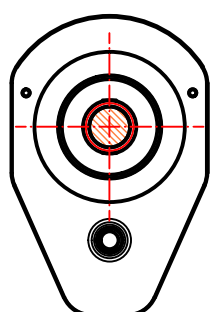
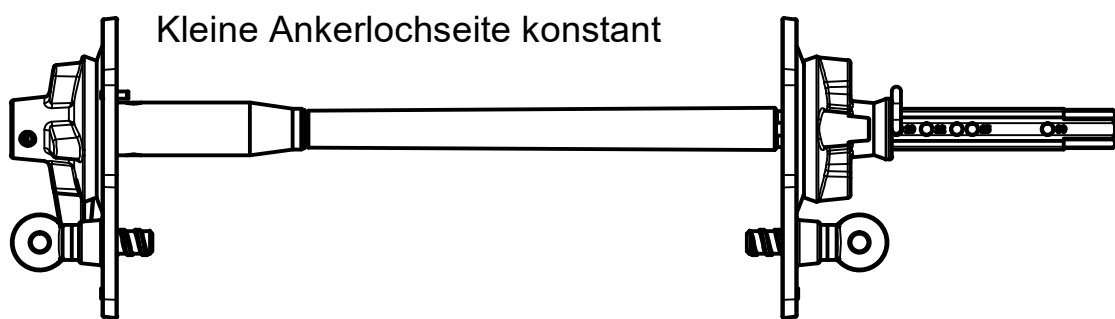
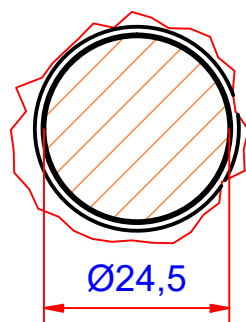
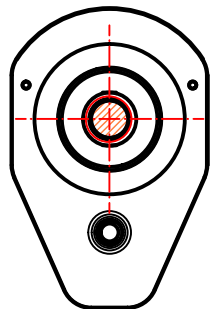

Anker MX 18 30-40
Artikel: 123903

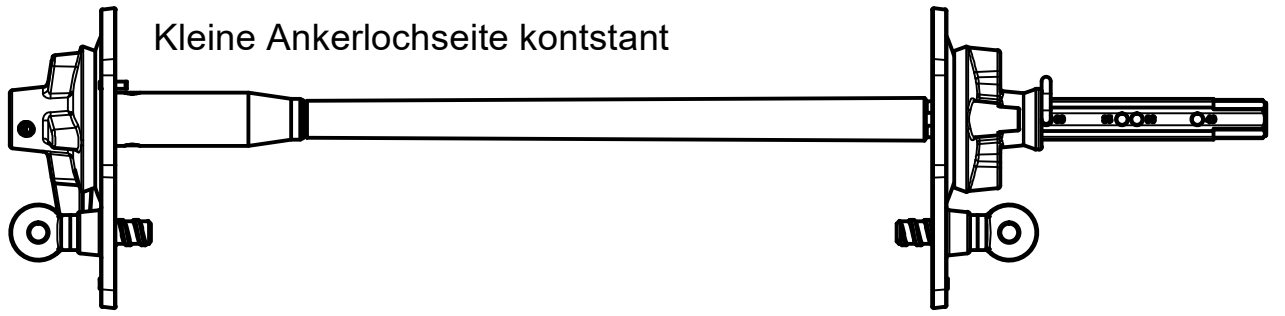
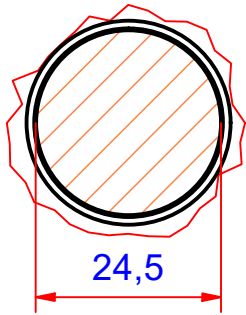
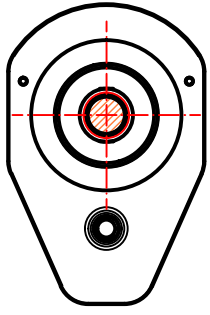

Kleine Ankerlochseite konstant

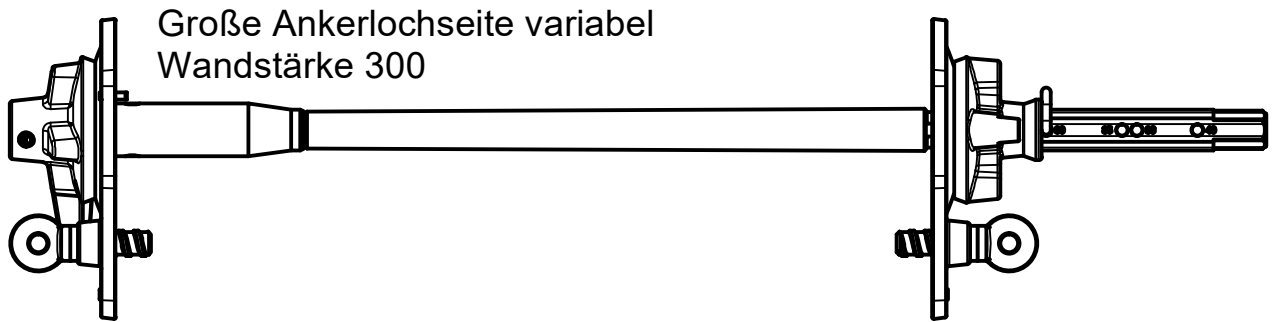
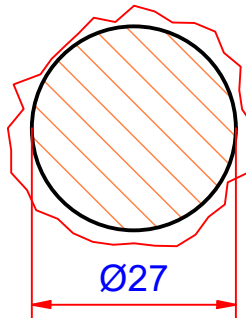
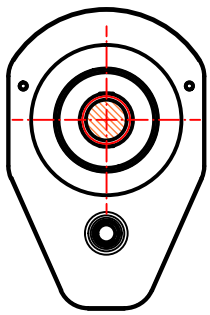

Große Ankerlochseite variabel
Wandstärke 300

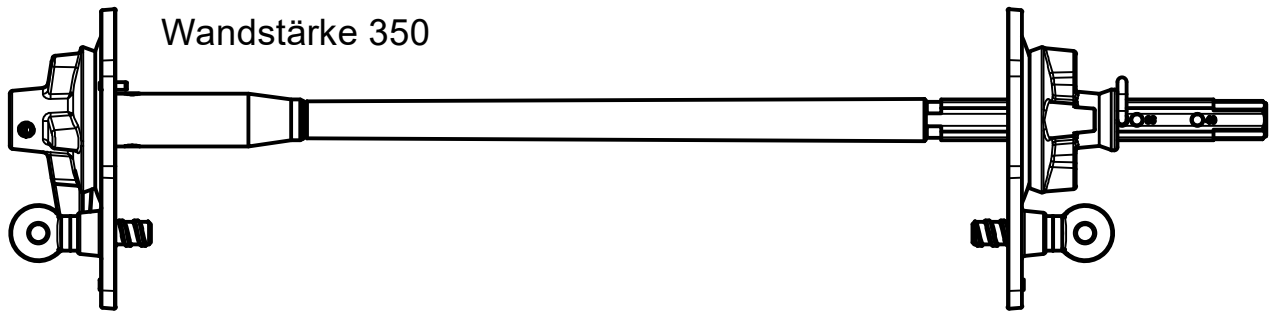
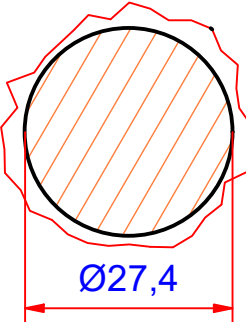
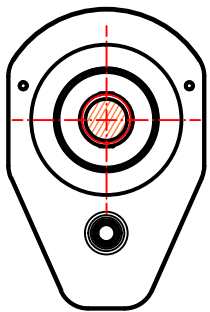

Wandstärke 350

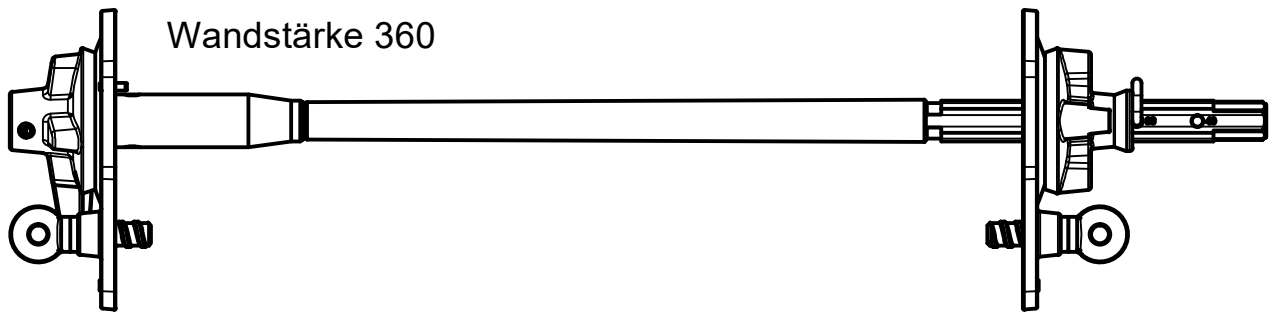
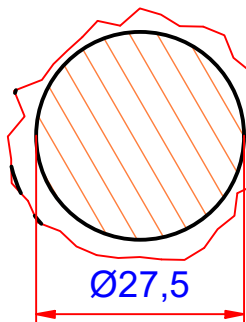
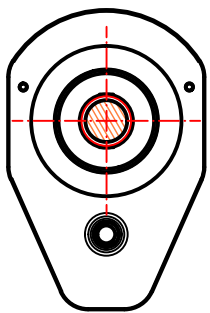

Wandstärke 360

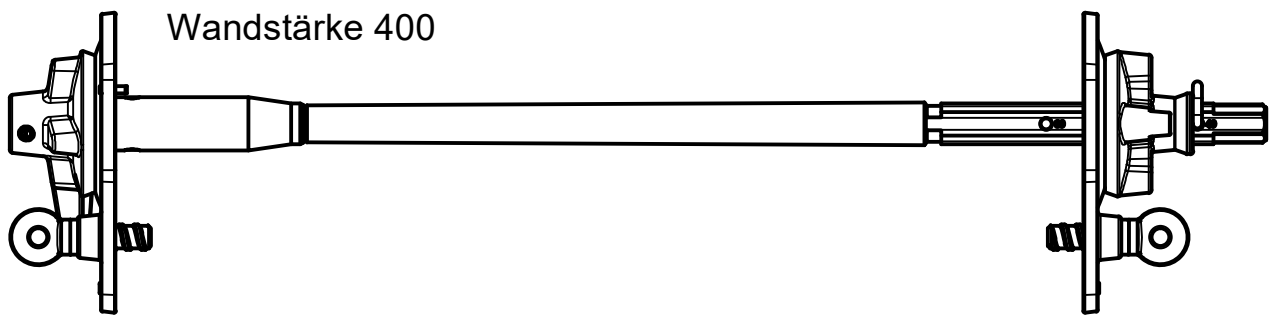
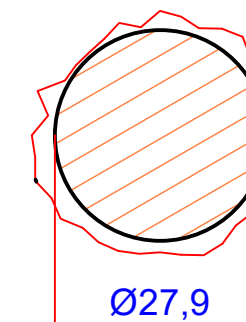
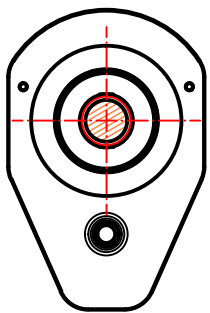

Wandstärke 400

Anker MX 18 40-50
Artikle: 123904

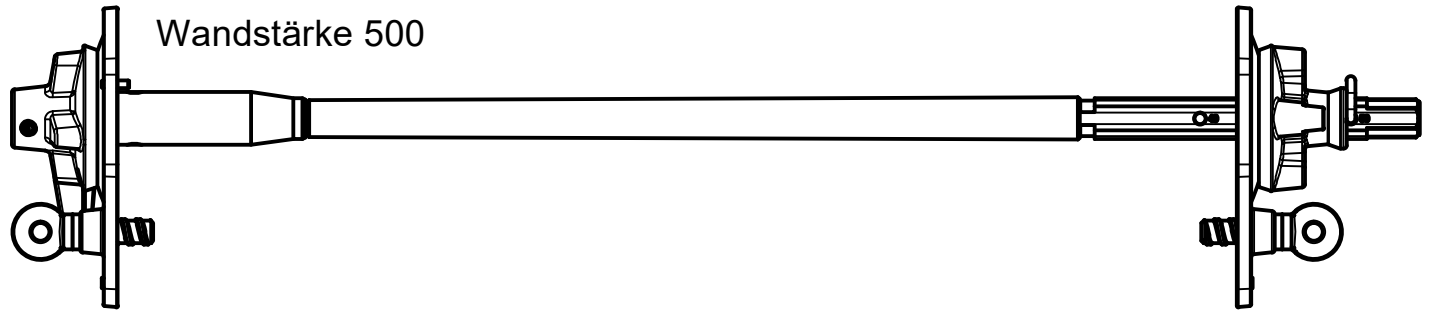
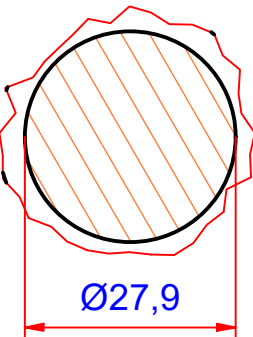
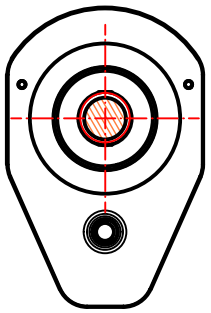
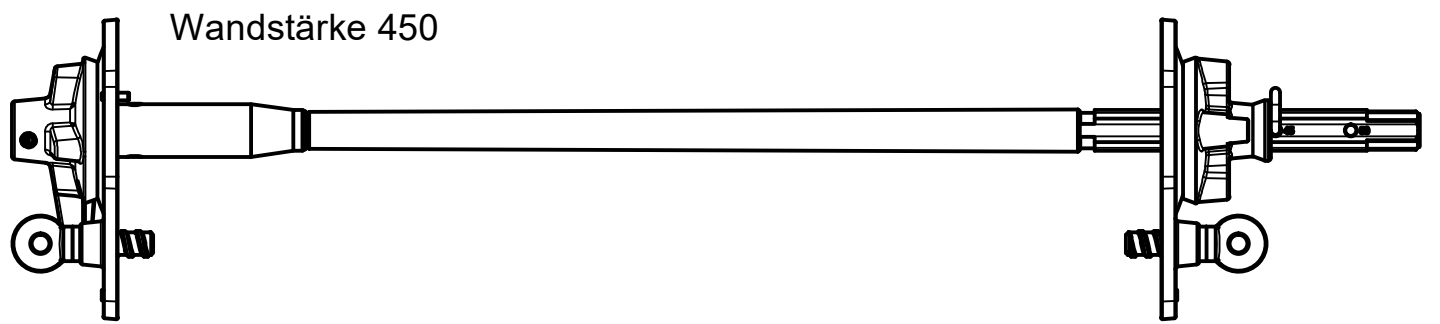
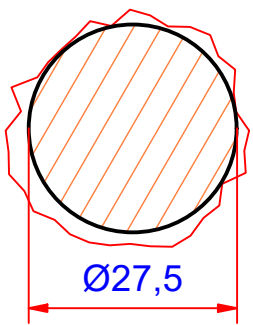
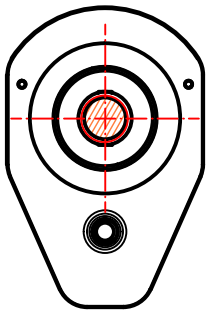
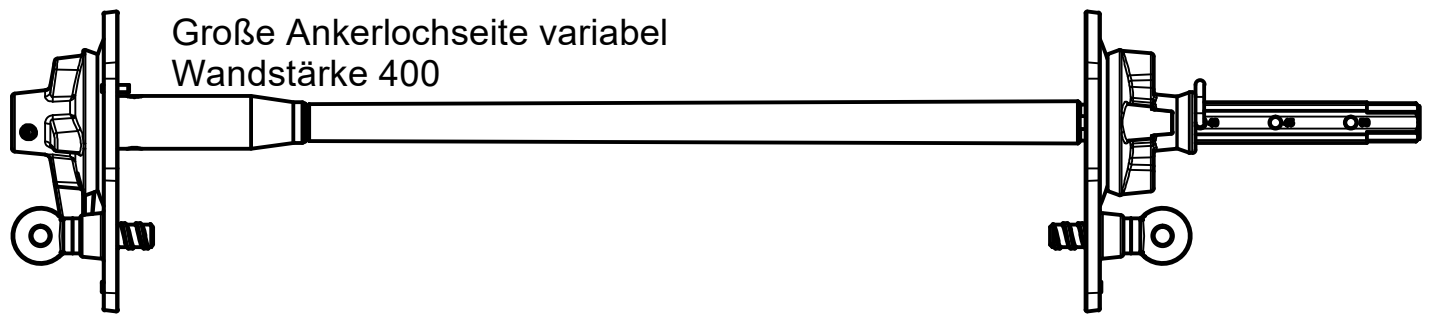
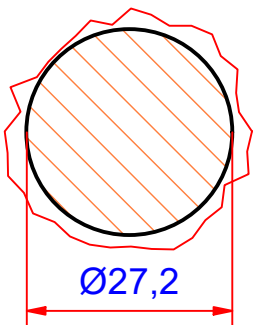
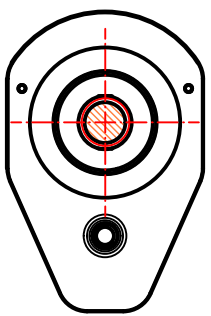
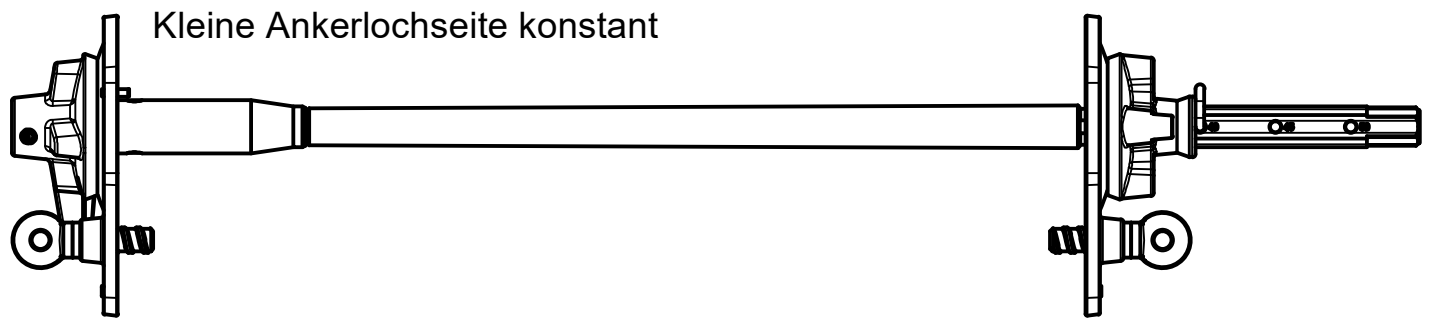
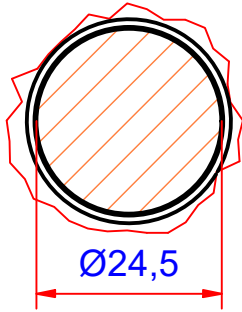
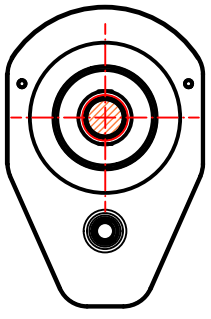

Anker MX 18 50-60
Artikel: 123905

